

SWIMMING



QUANTUM MOBILE HARNESS

User's Manual

3480.500.02

Version 1.1

Edition August 2019

Caution and safety precautions

- Never use any other charger than the supplied or a type approved by Swiss Timing. This could destroy the battery, cause damage to unit, and possible cause personal injury due to fire or/and electrical shock.
- Never bypass a power cord ground lead by breaking off the ground pin, or by using inappropriate extension cords or adapters.
- Never plug a power cord into the AC power source until you have made sure that all installation, cabling and power levels, are proper, and that the applicable procedures in this manual have been followed.
- Protect the equipment against splashing, rain and excessive sun rays.
- Never use the device if it is damaged or insecure.
- Verify the selection of the power distribution.
- Verify that the voltage quoted on the rating plate is the same as your voltage. Connect the appliance only to power sockets with protective earth. The use of incorrect connection voids warranty.
- This program may be modified at any time without prior notification.
- Do not open the case; there is nothing that needs servicing inside it. Nevertheless, if the case must be opened, you must call for some qualified personnel. The power supply cable must be disconnected before opening the case.
- During the transport of all Swiss Timing equipment delivered with a reusable carry case, the said case should be used at all times. This is imperative to limit the damage, such as shocks or vibration that can be caused to the units during transport.
- The same cases should also be used when returning equipment to Swiss Timing for repair. Swiss Timing reserves the right to refuse all guarantees if this condition is not fulfilled.
- If the installation includes a horn, be sure to maintain a sufficient security distance from the public.

Documentation Updates

Swiss Timing Ltd. reserves the right to make improvements in the products described in this documentation at any time without prior notice. Furthermore, Swiss Timing Ltd. reserves the right to revise this documentation in its content at any time and without any obligation to notify any person or organization of such revision.

Disclaimer

The information provided in this documentation has been obtained from sources believed to be reliable, accurate and current. However, Swiss Timing Ltd. makes no representation or warranty, express or implied, with respect, but not limited to, the completeness, accuracy, correctness and actuality of the content of this documentation. Swiss Timing Ltd. specifically disclaims any implied warranty of merchantability, quality and/or fitness for any particular purpose. Swiss Timing Ltd. shall not be liable for errors contained in this documentation or for incidental or consequential damages in connection with the supply, performance or use of this documentation.

Environment



This symbol indicates that this product should not be disposed with household waste. It has to be returned to a local authorized collection system. By following this procedure you will contribute to the protection of the environment and human health. The recycling of the materials will help to conserve natural resources.

Copyright

© Swiss Timing Ltd.

All rights reserved.

This documentation may not, as a whole or in part, be copied, translated, reproduced, transmitted or reduced and/or stored to any electronic medium or machine-readable form without the prior written consent of Swiss Timing Ltd.

TABLE OF CONTENTS

1	INTRODUCTION.....	1
1.1	Concept.....	1
1.1.1	PRIMARY mobile harness.....	1
1.1.2	PRIMARY & SECONDARY mobile harness	1
1.1.3	Mobile harness spare	1
1.2	Description.....	1
1.3	General view.....	1
1.3.1	PRIMARY MOBILE HARNESS	1
1.3.2	PRIMARY & SECONDARY MOBILE HARNESS.....	2
1.3.3	PRY or PRY & SDY MOBILE HARNESS SPARE	2
1.3.4	PROGRAMMER.....	2
2	INSTALLATION.....	3
2.1	Connection on the swimming pool's side	3
2.1.1	With all the peripherals.....	3
2.1.2	With the 3 pushbuttons.....	3
2.2	Connection on the control room's side with a mobile harness	4
2.3	Connection between the lanes.....	4
2.4	Chaining principle	5
3	PROPERTIES.....	6
3.1	Dimensions and weight.....	6
3.2	Maintenance	6
3.3	Storage.....	6
4	APPENDIX.....	7
4.1	Index of figures	7
4.2	Version history	7

1 INTRODUCTION

1.1 Concept

1.1.1 PRIMARY mobile harness

The purpose of the mobile harness is to connect the different elements (touch pad, starting block and pushbuttons) of a swimming lane to the timing system (Quantum).

1.1.2 PRIMARY & SECONDARY mobile harness

The primary & secondary mobile harness has the same functions as the primary harness but it has an additional electronic circuit which enables it to double the timing lane when using a secondary (Quantum).

1.1.3 Mobile harness spare

The spare harness allows choosing the lane; it is used for the replacement of a defective standard harness during a competition (maximum two modules by harness lane). This model is dedicated in PRIMARY or PRIMARY & SECONDARY).

1.2 Description

The mobile harness is made with a case which shows the number of the corresponding swimming lane and it is available from lanes 0 to 9.

The side with the banana plugs is used for the connection of the contacts (touch pad, starting block and pushbuttons).

The banana plugs connected by a white line are the common feature; they are electrically connected inside the harness.

The codification of the water lanes is made by Swiss Timing before delivery. In case of replacement on site, a programmer can be ordered (see chapter 1.3.4).

1.3 General view

1.3.1 PRIMARY MOBILE HARNESS

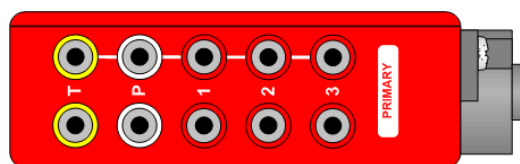

Figure 1 – Primary mobile harness

- 3480.950 Set of Primary mobile harness 10 lanes
- 3480.958 Set of Primary mobile harness 8 lanes
- 3480.956 Set of Primary mobiles harness 6 lanes

1.3.2 PRIMARY & SECONDARY MOBILE HARNESS

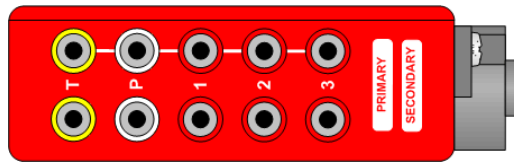

Figure 2 – Primary & Secondary mobile harness

- 3480.960 Set of Primary & Secondary mobile harness 10 lanes
- 3480.968 Set of Primary & Secondary mobile harness 8 lanes
- 3480.966 Set of Primary & Secondary mobile harness 6 lanes

1.3.3 PRY or PRY & SDY MOBILE HARNESS SPARE

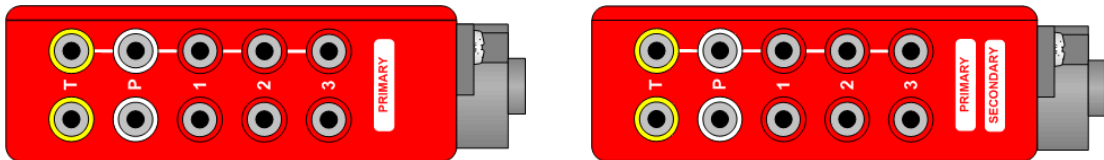

Figure 3 – PRY or PRY & SDY mobile harness spare

- 3480.75X Primary mobile harness spare
- 3480.76X Primary & Secondary mobile harness spare

1.3.4 PROGRAMMER

The codification of the water lanes is made by Swiss Timing before delivery. In case of replacement on site, a programmer can be ordered (see *Manual 3480.501.02*).

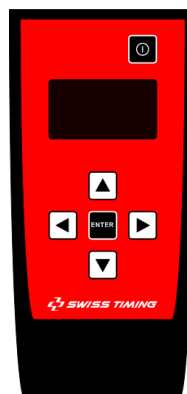

Figure 4 – Programmer

- 3480.921 Set of Primary harness programmer with a Primary harness
- 3480.922 Set of Primary & Secondary harness programmer with a PRY & SDY harness

2 INSTALLATION

Each element connects itself on the banana plug, depending on the colour of the peripherals.

Yellow	OCP5	Touch pad
White	OSB11	Starting block
Red	OIT	Pushbutton

2.1 Connection on the swimming pool's side

2.1.1 With all the peripherals

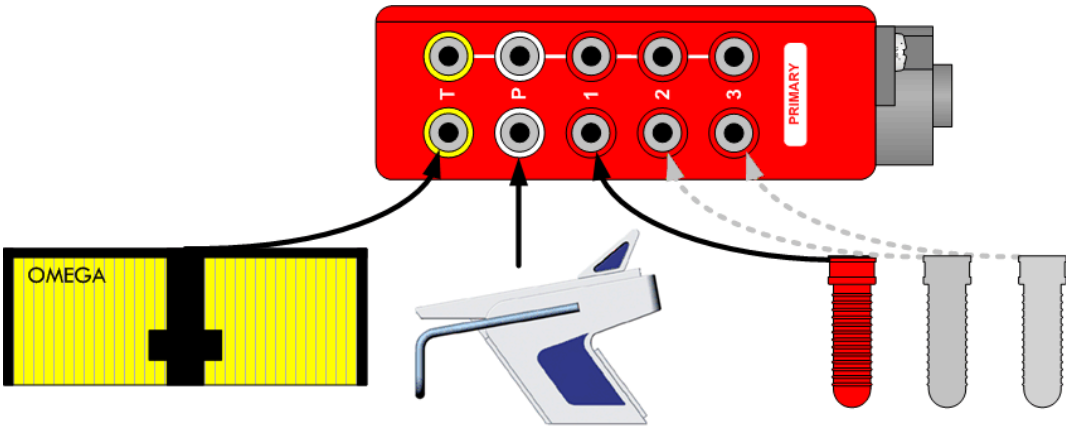

Figure 5 – Connection with the peripherals

2.1.2 With the 3 pushbuttons

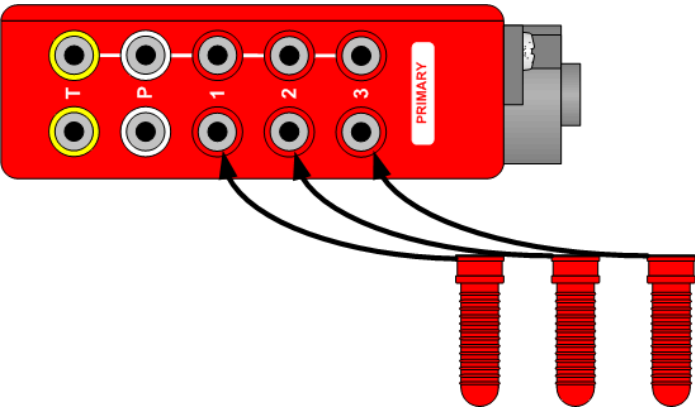

Figure 6 – Connection with the 3 pushbuttons

2.2 Connection on the control room's side with a mobile harness

Using the 25m cable (1892.025) delivered in a standard configuration, you can connect the first harness to the Quantum.

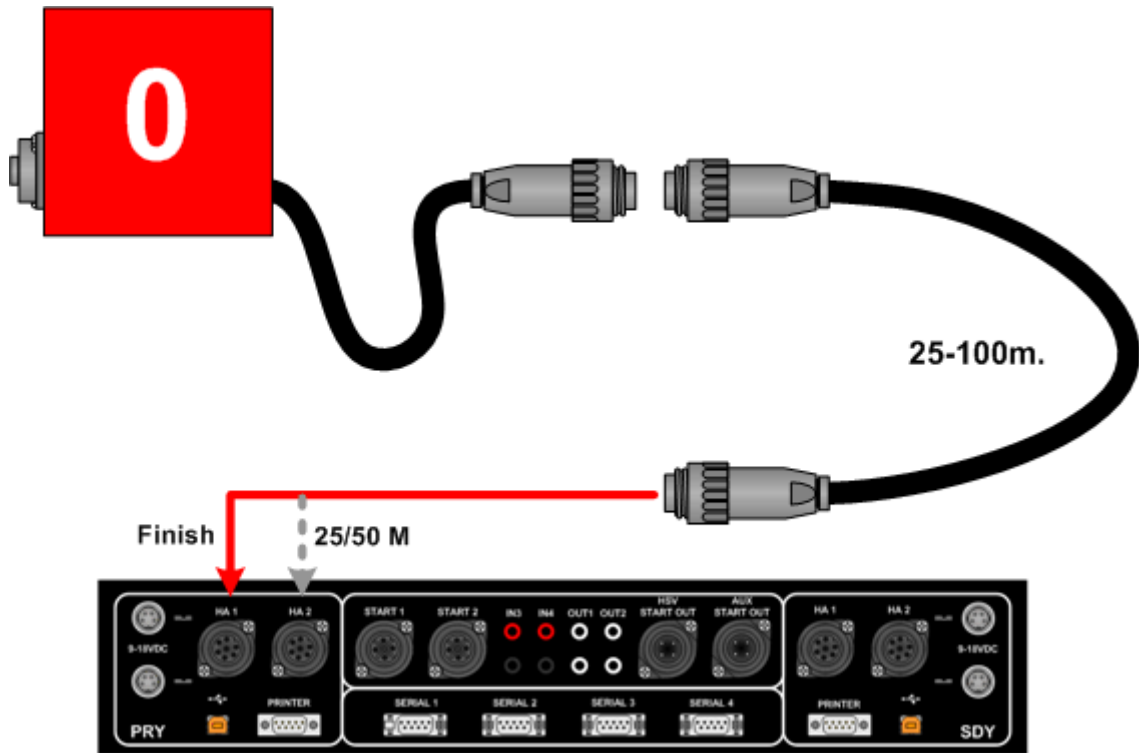

Figure 7 – Connection to the timing system (Quantum)

- 1892.025 Harness cable – Quantum 25 meters
- 1892.050 Harness cable – Quantum 50 meters with drum
- 1892.075 Harness cable – Quantum 75 meters with drum

2.3 Connection between the lanes

The connection between the lanes is made with the help of the Tu7p Male cable that connects itself on the socket Tu7p Female of the previous harness.

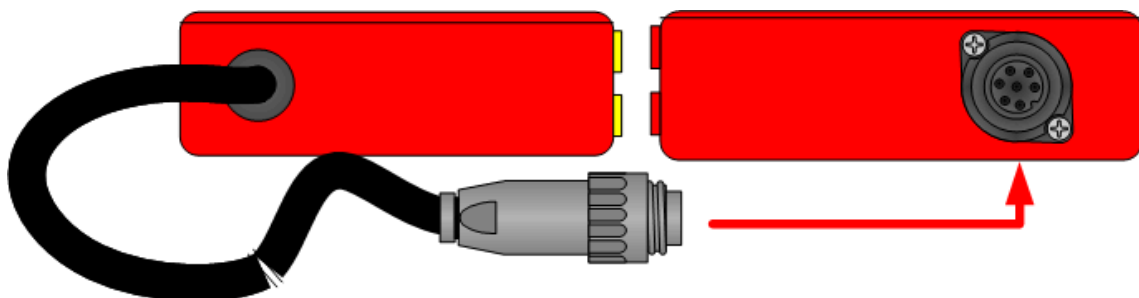

Figure 8 – Cables side (previous harness and Quantum) and Tuchel (next harness)

2.4 Chaining principle

Depending on the quantity of lanes used, it is possible to chain up to 10 mobile harnesses on each end of the pool.

A provided terminator n° 3480.770 needs to be connected on the last harness.

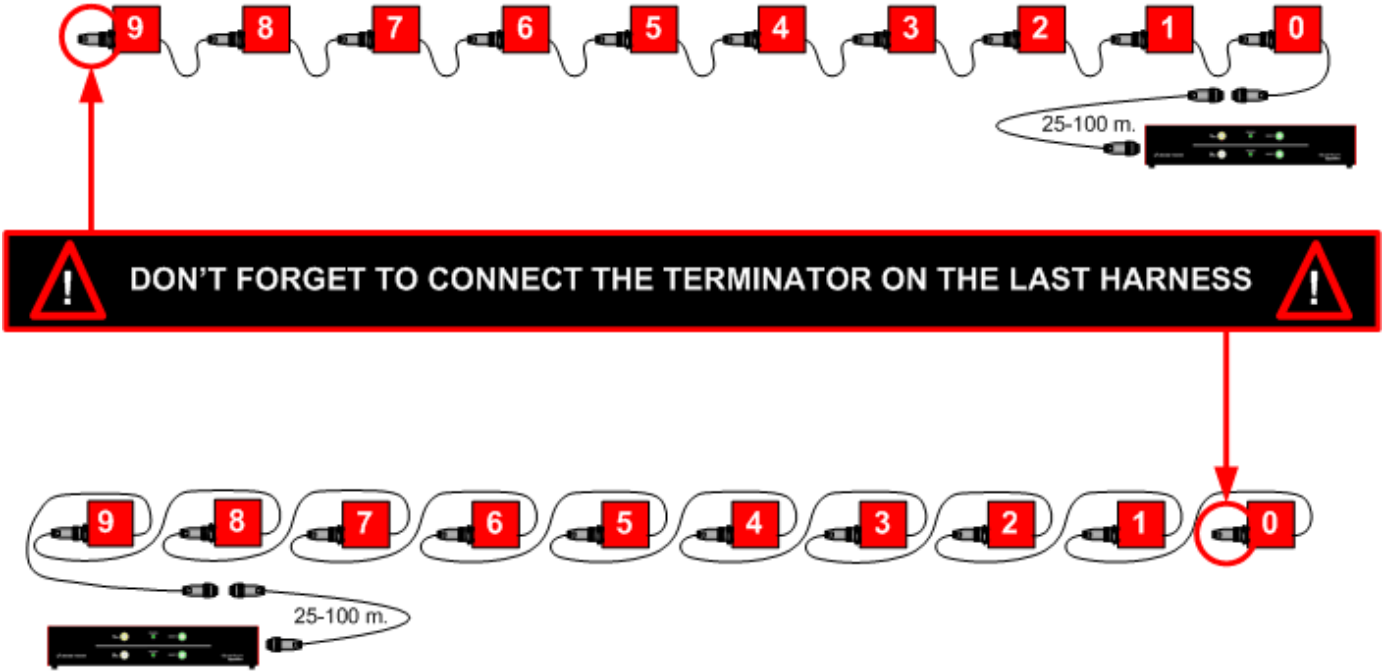
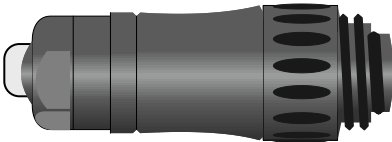

Figure 9 – Chaining of the mobile harnesses with Quantum

3480.770

Harness terminator



3 PROPERTIES

3.1 Dimensions and weight

Dimension of mobile harness: Hx105/Wx105/Dx36 + 3m cable

Case weight:

Primary mobile harness: 0.760 kg

Primary & Secondary mobile harness: 0.865 kg

3.2 Maintenance

After each use, clean the harness using a wet cloth (without additives). Fill up the banana plugs with RHODORSIL B431 paste (RHODIA SILICON) n° 9038.7047

3.3 Storage

The mobile harness must be kept in a clean and dry place.

The storage temperature is -10°C to +60°C whereas the working temperature is 0°C to +45°C.

4 APPENDIX

4.1 Index of figures

Figure 1 – Primary mobile harness 1

Figure 2 – Primary & Secondary mobile harness 2

Figure 3 – PRY or PRY & SDY mobile harness spare..... 2

Figure 4 – Programmer 2

Figure 5 – Connection with the peripherals 3

Figure 6 – Connection with the 3 pushbuttons 3

Figure 7 – Connection to the timing system (Quantum)..... 4

Figure 8 – Cables side (previous harness and Quantum) and Tuchel (next harness)..... 4

Figure 9 – Chaining of the mobile harnesses with Quantum 5

4.2 Version history

Version	Modifications since last version
1.0	Initial version
1.1	Chapter 1.3.4 & 2.4 updated

NOTES

